

Hypertherm[®]

CAD/CAM software family

Nesting, tube and pipe, sheet metal layout

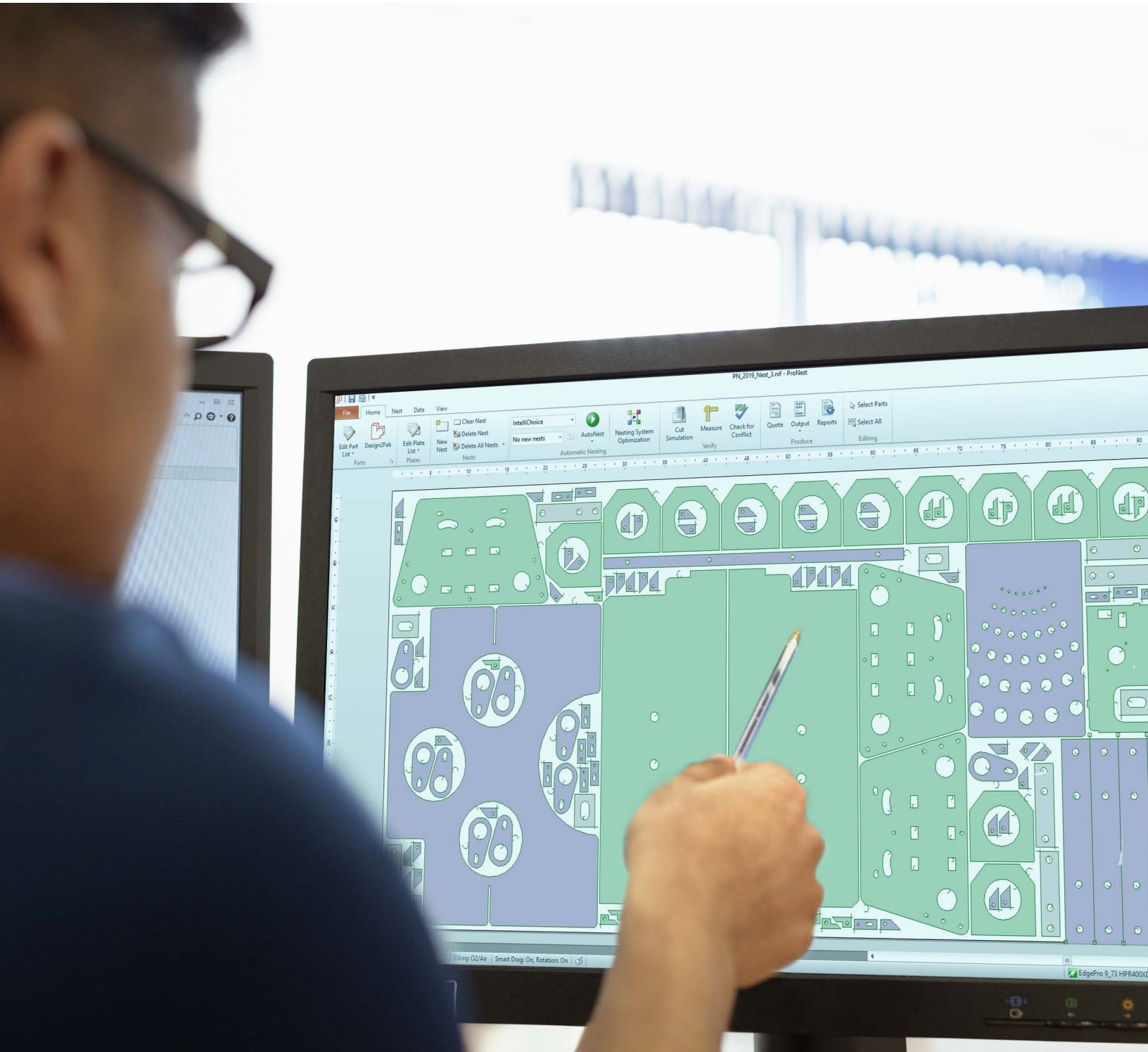

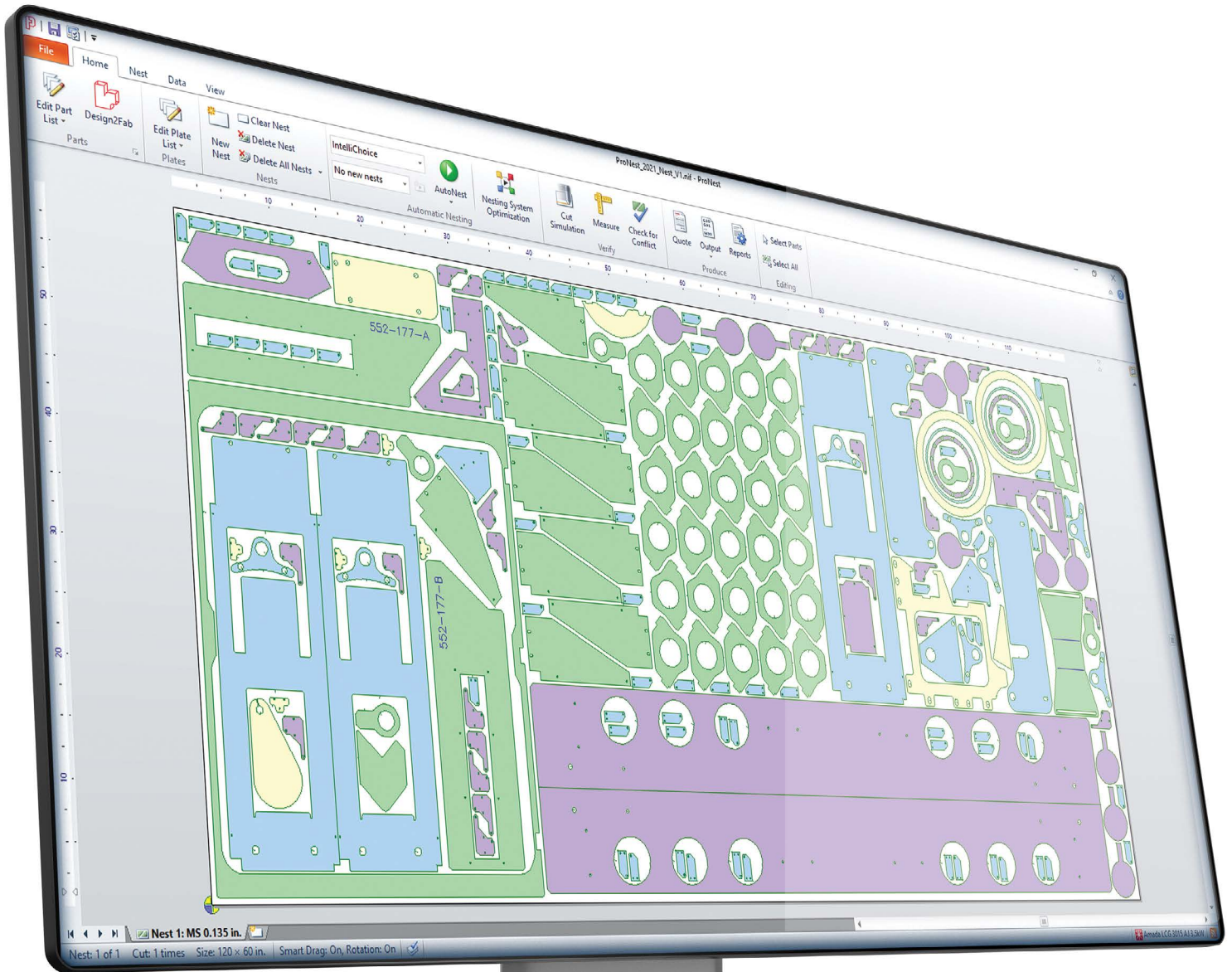

Contents

- 4 The Hypertherm CAD/CAM difference
- 5 Accomplish more with ProNest®
- 8 The CAD/CAM software family
- 12 Rotary Tube Pro™
- 13 Design2Fab®
- 15 Shaping Possibility®



The Hypertherm CAD/CAM difference

Are you getting the most out of your cutting operation? Easy-to-use Hypertherm® CAD/CAM software for nesting, tube and pipe, and sheet metal layout can help you achieve greater automation, efficiency, and profitability. Over 50 years of cutting experience has gone into our product development, and Hypertherm CAD/CAM software contains more built-in process expertise than any other brand.

ProNest®, our advanced CAD/CAM nesting software, automatically embeds this cut process expertise into the numeric code. Whether it's material type, thickness, or grade, ProNest is drawing on years of research and development to deliver the optimal adjustments including leads, separations, kerf, and feedrate. ProNest is also the only software with full support for Hypertherm SureCut™ technologies like True Hole®, and Rapid Part™, which are delivered automatically without operator intervention, and True Bevel™ which greatly reduces bevel set up time.

Rotary Tube Pro™ provides a complete design and cut solution for tube and pipe parts with no 3D CAD experience required. And Design2Fab® provides a simple, yet powerful interface for sheet metal layout, including HVAC, and other applications.

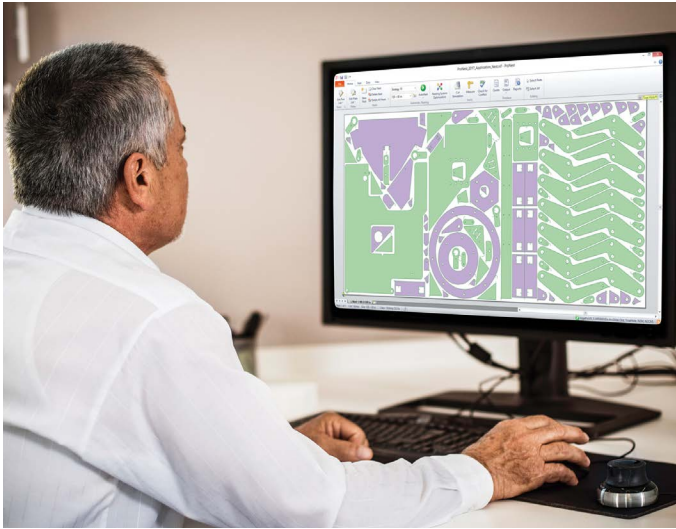

Accomplish more with ProNest

ProNest® is an industry leading CAD/CAM nesting software designed for advanced mechanized cutting. It provides a single solution for all of your profile cutting needs, including plasma, laser, waterjet, and oxyfuel.

ProNest offers all of the standard features you'll need to complete your jobs, plus optional modules for more advanced functionality.

Users agree this powerful software is incredibly easy to learn and use. Your team will be up and running faster, and completing jobs more quickly.

ProNest workflow ... customizable to meet your needs



Are you maximizing your results?

ProNest® helps fabricators, manufacturers, and metal service centers achieve better results. Here are some of the ways ProNest can impact your business.

Single software solution



“ProNest allows me to program eight different machines which has more than doubled our programming productivity.”

- Olympic Steel Inc.

Faster programming



“Jobs that used to take 8 hours to program now take 5 to 10 minutes with ProNest.”

- Creative Edge Master Shop

Increased material utilization



“With ProNest we’ve increased material utilization by 5%, which translates to \$50,000 annually.”

- Construction Products Inc.

Better part quality



“True Hole improves the look and quality of our products, and ProNest makes it easy.”

- T&J Manufacturing



Applications supported

Regardless of which cut process, application, machine format, brand, or model you're using, Hypertherm® has the solution for you.

Plasma



Laser



Waterjet



Oxyfuel



Bevel



Drill



Plate



Reposition



Rotary pipe/tube

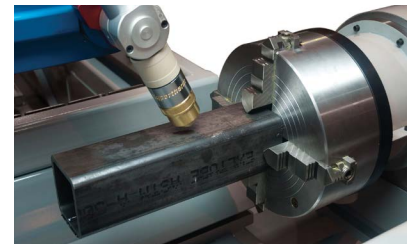

SureCut™

ProNest is the only software that offers full support for Hypertherm SureCut technology, including:

True Hole®

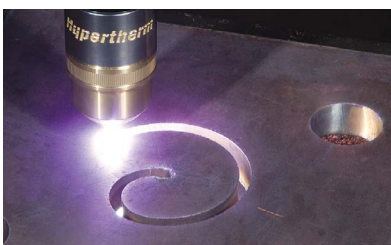

Rapid Part™

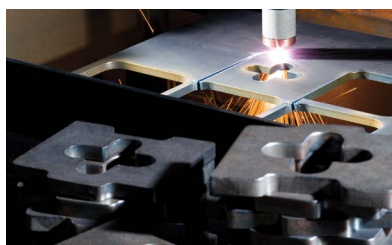

True Bevel™



The CAD/CAM software family

Hypertherm® offers several CAD/CAM software products designed to drive your machines and improve your business productivity and profitability



ProNest® 2021

Nesting software for advanced mechanized cutting in enterprise and production environments.



ProNest® 2021 LT

Nesting software for light industrial mechanized cutting in production environments.



Rotary Tube Pro™

Pipe and tube cutting software for stand-alone tube cutting machines or cutting table add-ons.





Design2Fab®

Sheet metal layout software for HVAC, duct work, mechanical, kitchen, industrial, roofing, and more.

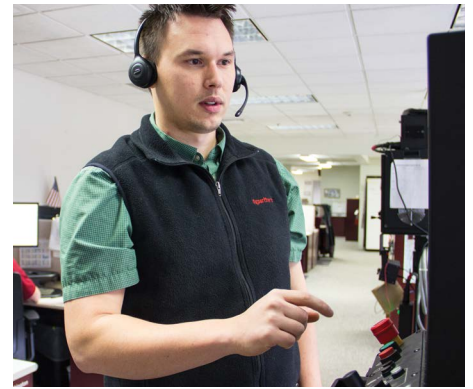

World class support

ProNest®, Rotary Tube Pro™, and Design2Fab® are backed by Hypertherm's global network of professionals, meaning you will always have access to the service and support you need. Our team has decades of experience in CAD/CAM software, plus many years applications experience working in various cutting industries.

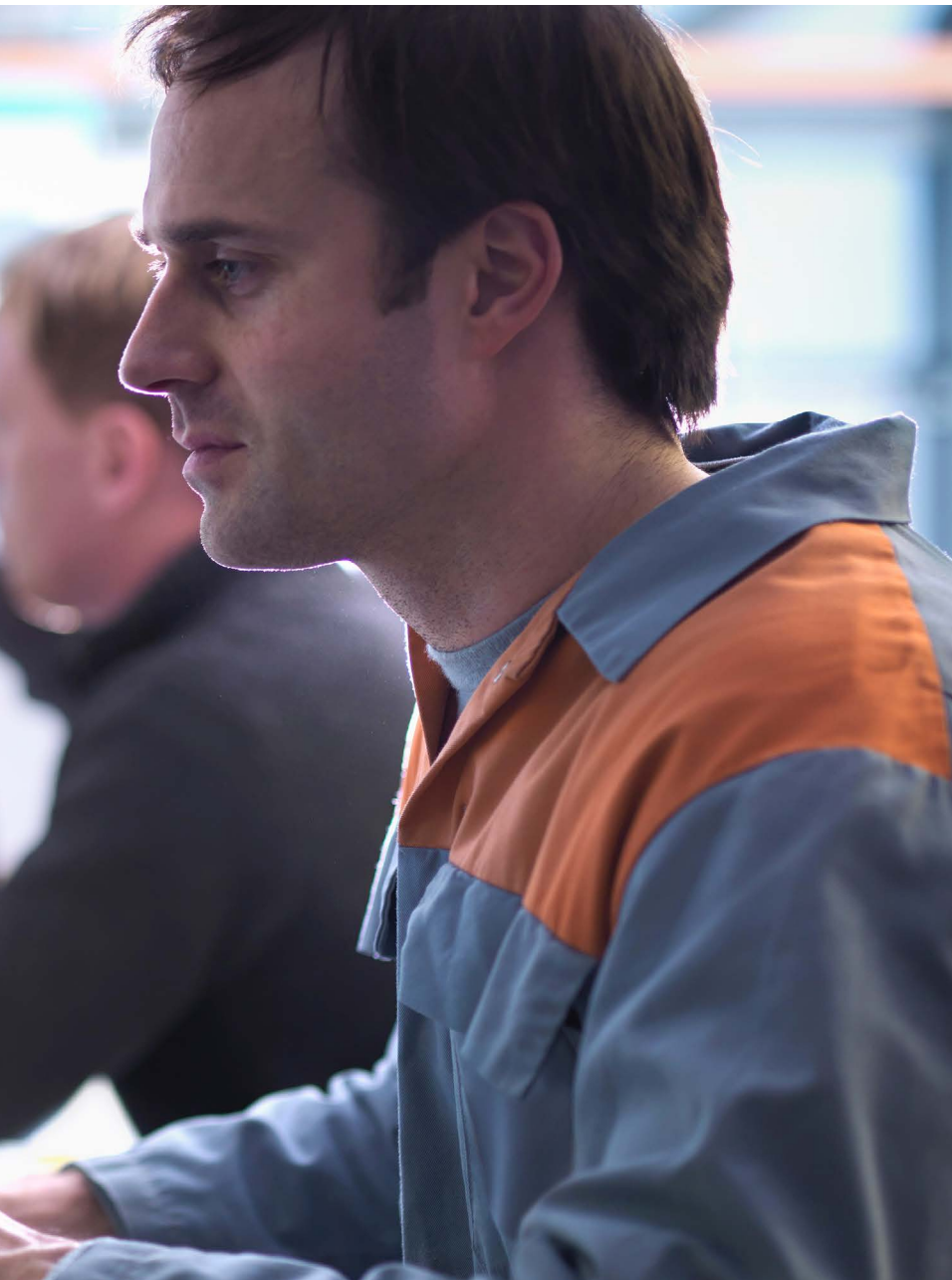

Beyond nesting

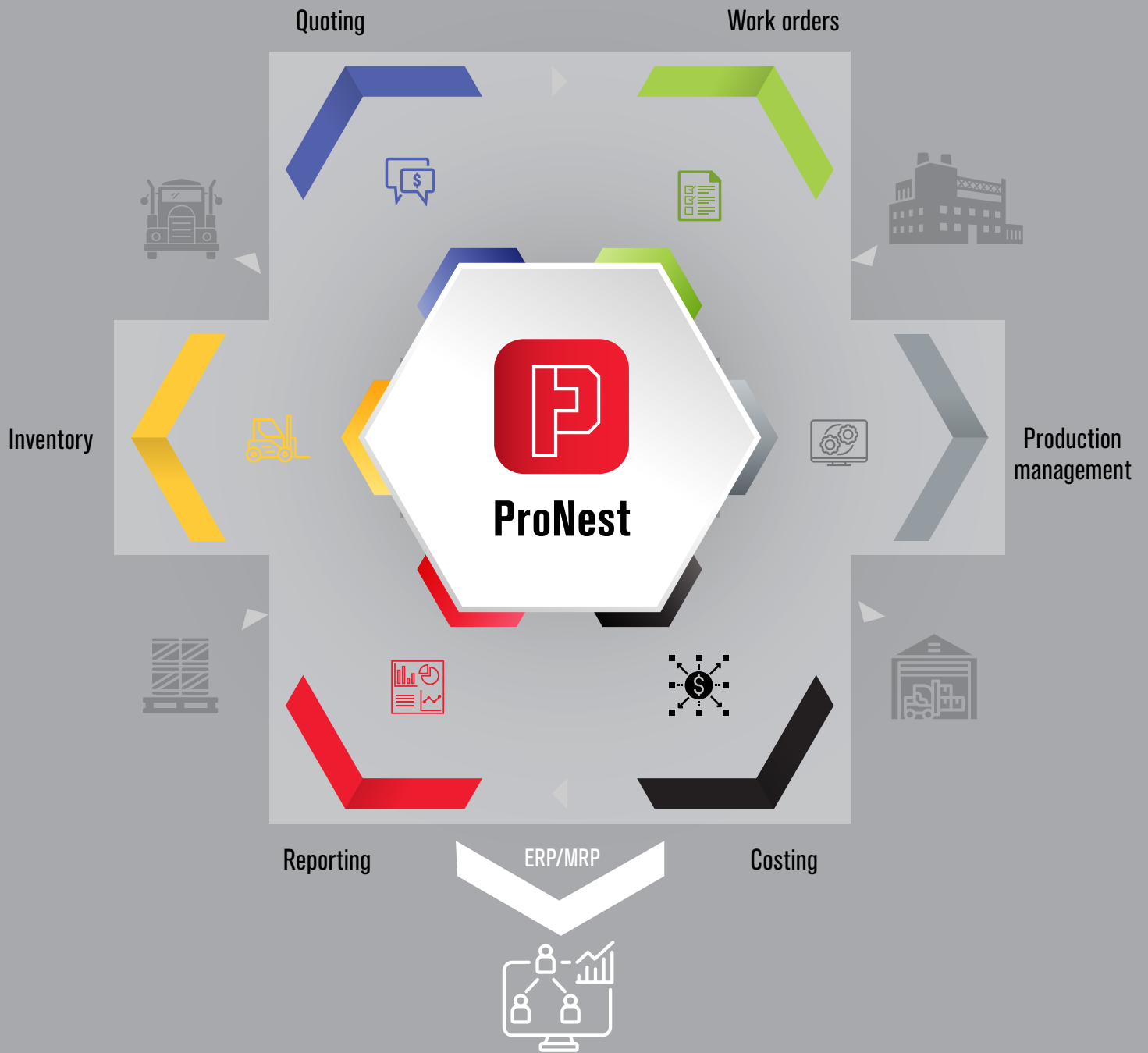

ProNest® not only drives your machines, it is also a key component of your entire cutting and fabricating ecosystem, going from quoting to reporting, and everything in between. ProNest also connects to ERP/MRP for real time data exchange.

ProNest® product comparison summary

The following guide illustrates the basic differences between levels. For more detailed feature information, please visit www.hypertherm.com/CAM.

Key features legend

- Advanced
- Intermediate

	ProNest	ProNest LT
Machine support		
All major brands	●	●
Cut process support		
Plasma – conventional air / oxygen (ex. Powermax®, MAXPRO®)	●	●
Plasma – high definition (ex. XPR™, HyPerformance®)	●	
Laser	●	
Waterjet	●	
Oxyfuel	●	●
Standard features		
Part design	●	●
CAD import	●	●
Manual nesting	●	○
Reporting	●	○
Costing	●	○
Quoting	●	
A single job can contain sheets for different material types, thicknesses, and classes	●	
SureCut™ technology		
True Hole® technology capable*	●	
Rapid Part™ technology capable*	●	
True Bevel™ technology capable*	●	
Advanced process support and job set up on the CNC*	●	
Module highlights		
Automatic Nesting	●	○
Productivity modules	●	○
Enterprise modules (including ERP/MRP integration)	●	
3D CAD modules	●	

*Certain hardware and software requirements may apply.

Rotary Tube Pro

An easier way to design and cut tubes

Rotary Tube Pro™ offers a complete design and cut solution for tube and pipe parts in mechanized cutting applications including plasma, laser, waterjet, and oxyfuel. There is no 3D CAD experience required. Tubes and branches are easily created using parametric input. Side-wall cut outs can be selected from a list of pre-defined shapes, or added from CAD. And, if necessary, users can import 3D CAD files. This flexibility allows fabricators and manufacturers to work more efficiently, boost productivity, and reduce operating costs.

In addition, Rotary Tube Pro supports virtually all brands of tube cutting machine, including stand-alone units and cutting table add-ons. It supports perpendicular cutting as a standard feature and bevel cutting as an optional module.

Standard feature highlights:

- Machine support for all major brands
- Cut process support for plasma, laser, waterjet, and oxyfuel
- Part creation and development
- Automatic nesting
- Common line cutting
- SureCut™ technology capable including True Hole®
- Reporting with detailed job information
- Simplified costing
- Output with advanced post-processor
- Bevel cutting option

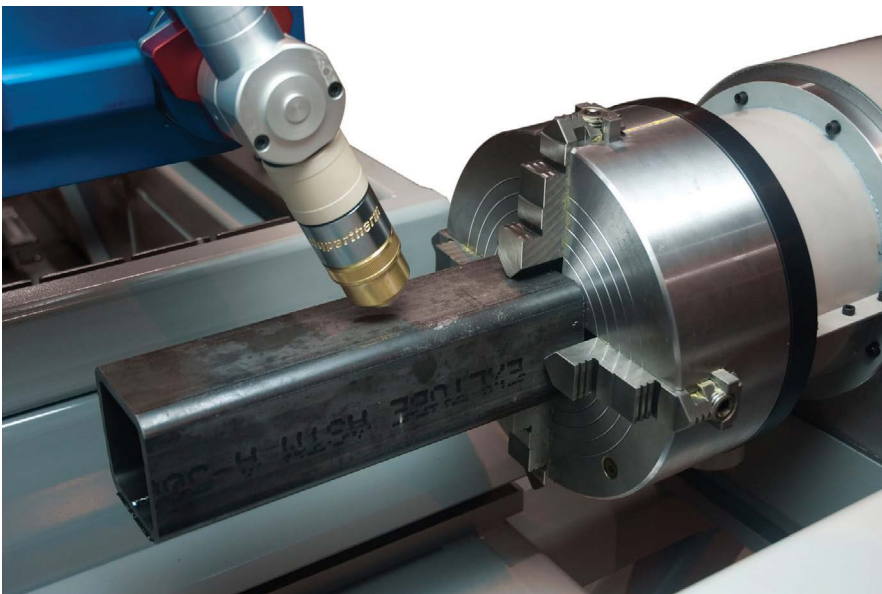
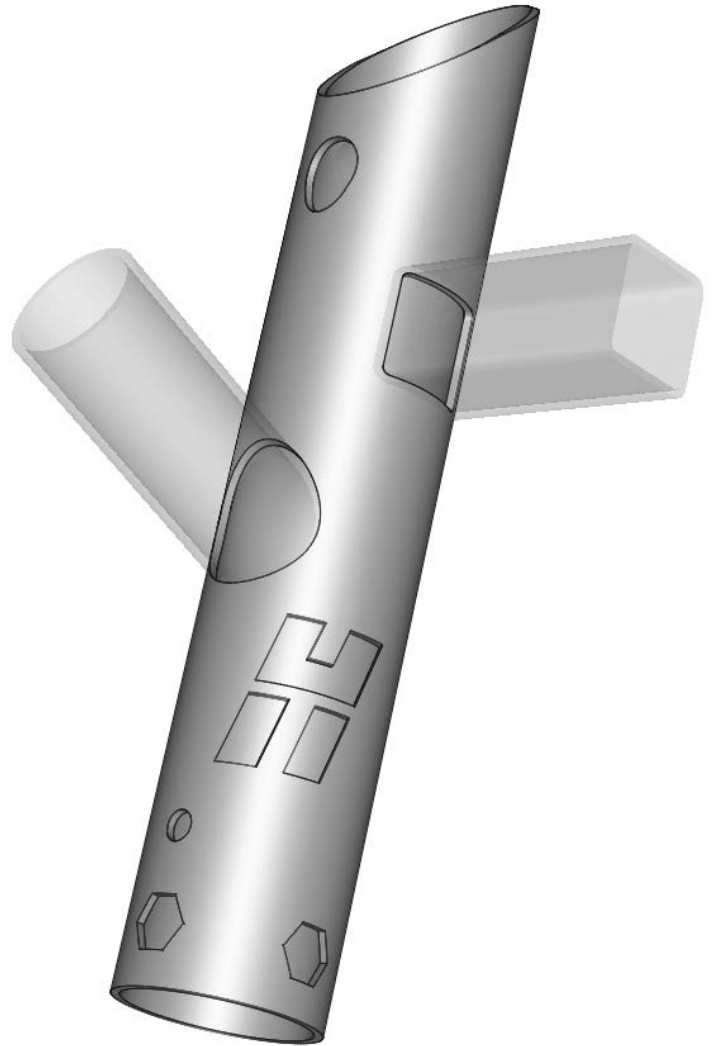

Design2Fab

Sheet metal layout made fast and efficient

Design2Fab® sheet metal layout software makes it easy to create HVAC duct, mechanical, kitchen, industrial, roofing, and other specialty fitting layouts. Engineered to dramatically reduce the time it takes to develop and lay out flat patterns, Design2Fab provides sheet metal fabricators, HVAC shops, and MEP contractors with the ability to create complex custom fitting layouts in minutes, rather than hours. Design2Fab also helps ensure perfect fit-up when installing parts in the field, contributing to increased productivity and lower operating costs so you'll be able to accomplish more, while increasing profitability!

Standard feature highlights:

- Comprehensive fittings library with unlimited customization
- 3D view verification of fittings
- 2D layout view of pattern fitting
- Copy fitting or zone
- Apply SMACNA or DIN standards
- DXF export for nesting and automated cutting
- HPGL export for printing and manual cutting

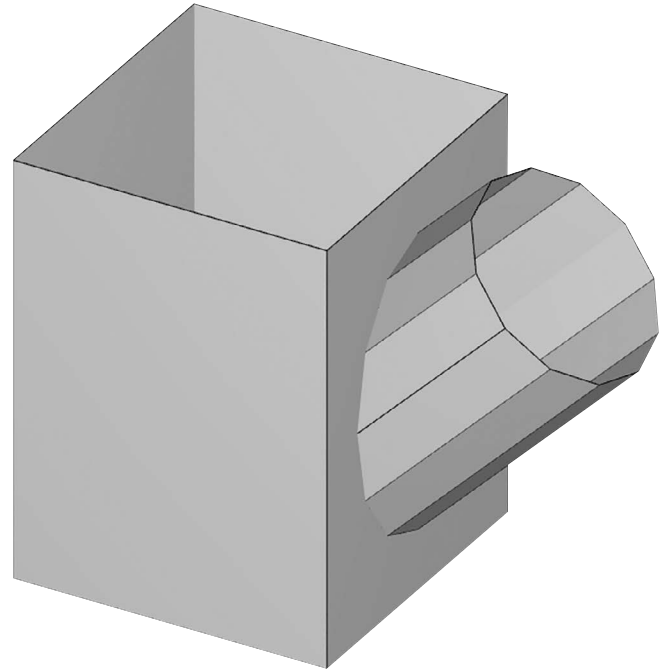



Shaping Possibility®

With the right tools and a relentless focus on innovation, partnership, and community, we believe anything is possible.

More than fifty years ago, in a small two car garage, Hypertherm® began our journey with simple, powerful ideas about business and an invention that shaped the future of industrial cutting. The same ideals that fueled our inception all those years ago are still what drive us today: a passion for challenging what is achievable with the products we create, the culture we foster, and the experience we deliver to our customers. As we look to the horizon and the next 50 years, we are proud that our people, partners, and innovations will shape the future with solutions that make anything possible for industries around the world.

At Hypertherm, we give shape to our customers' vision with the world's leading industrial cutting solutions. Every day we help individuals and companies around the world envision better, smarter and more efficient ways to produce the products that shape our world. So whether you're cutting precision parts in North America, constructing a pipeline in Norway, fabricating agricultural machinery in Brazil, cutting stone in Italy, gouging out welds in the mines of South Africa, or building a skyscraper in China, you can count on Hypertherm to help you not just cut parts but achieve your vision.

100% employee ownership matters

At Hypertherm, we are not just employees: we are all owners. Ownership is a powerful motivator that ensures our customers are our top priority. As owners, we make sure every product is built to the highest quality and that our service is second to none. And we build long-term relationships that deliver value for us, our partners and our customers.

Worldwide presence and strength

Hypertherm is a key partner for your fabrication needs and has built a global organization focused on providing high-performance cutting solutions.

Key elements of the Hypertherm formula include:

- Dedicated Associates focused on customer-centered product design and support
- Local sales and service
- Broad application experience and proven results
- Sustainable and ethical business practices benefit our customers and communities

**HELPING YOU
SHAPE THE WORLD.**



PLASMA | LASER | WATERJET | AUTOMATION | SOFTWARE | CONSUMABLES

Request a free trial at: www.hypertherm.com/CAM

Hypertherm, ProNest, SureCut, True Hole, Rapid Part, True Bevel, Rotary Tube Pro, Design2Fab, Powermax, MAXPRO, XPR, HyPerformance, HyIntensity, and HyPrecision are trademarks of Hypertherm, Inc. and may be registered in the United States and/or other countries.

Please visit www.hypertherm.com/patents for more details about Hypertherm patent numbers and types.

© 12/2020 Hypertherm, Inc. Revision 6

896970

As 100% Associate-owners, we are all focused on delivering a superior customer experience. www.hypertherm.com/ownership

Environmental stewardship is one of Hypertherm's core values. www.hypertherm.com/environment

Hypertherm[®]
SHAPING POSSIBILITY[®]

100% Associate-owned

